



**Installation Instructions for the EVO3
Height-Adjustable Ultimate Short Shifter**

***for 1996-1999 M3 6-speed models only
UUC part number USSE62***

Thank you for purchasing the Ultimate Shift Kit. Please read these directions thoroughly and become familiar with the procedure.

IMPORTANT – BEFORE BEGINNING ANY WORK:

- UUC recommends installation only by trained professionals, or those of sufficient mechanical skill to undertake this procedure safely.
- Please review the parts list and confirm that all parts are there.
- We strongly urge the installer to follow this guide step-by-step.

PARTS LIST (PLEASE CHECK BEFORE DISASSEMBLING CAR:

- 1 - EVO3 Height-Adjustable Ultimate Short Shifter lever with integral bearings and self-adjusting main pivot bearing assembly.
- 1 – Pivot height adapter assembly that includes:
 - Six (6) Stainless Steel M3 x 8 locator bolts
 - 2.5mm Allen hex key
 - Small tube of Loctite 242 Threadlock
- 1 - plastic washer
- 1 – Circlip
- 1 - Small tube of lubricant
- 1 - Installation Guide (this document)
- 2 - Oval Delrin carrier bushings
- 1 - Replacement Carrier Clip

Recommended items to have available during assembly:

- paper towels
- work light
- flat bladed screwdriver
- snap ring pliers
- work gloves
- 24mm open-ended wrench (or adjustable wrench) for height-adjustments
- needle-nose pliers



Car Preparation

Make sure that you perform this procedure when the car is cool. It is recommended that you lift the car up onto jack stands the night before this installation as the exhaust and drivetrain components do radiate a lot of heat. You may run the risk of being burned.

Jack up the car and support the entire car using jackstands only or an automotive lift! NEVER use a jack to support the car when working underneath. Serious injury or death may occur if your car is not properly supported. If you need help, ask someone with more experience, or have the kit installed by a professional mechanic.

Removing the shift boot

Remove the Shift Boot From within the car, lift up on the shift boot, a prying it off the console with your hands, by pulling on either side of it to release the clips holding it down. At this point, if you have an illuminated shift knob, disconnect the wires at the clip-together connection.





Removing the shift knob (continued)

Remove the shift knob by pulling straight up with a firm tug. Be careful as you may accidentally hit yourself in the face when the knob lets go or hit the rear view mirror since you are tugging at it so hard. Position yourself so that you cover the shifter knob like you are pulling it into your stomach.



Disconnect the lighted shift knob wire.



Remove the foam padding underneath the shifter boot:





Pull up the rubber shifter boot with your fingers so that it is just connected to the shifter lever.



Disconnecting the Selector Rod from the Stock Shifter - done underneath the car.

(Note: Aluminum carrier, shifter lever, and nylon cup removed from car to show detail.)

Remove the circlip and yellow washer that connects the linkage arm to the bottom of the shifter lever.

You may be able to push the circlip off with finger pressure (use gloves for protection). If the clip is really stubborn or rusty, use circlip pliers or a flat bladed screwdriver.

Do not worry about damaging the clip, a replacement has been included with the new shifter assembly.

Remove the first yellow washer (under the clip) and then disconnect the linkage arm from the shifter lever.

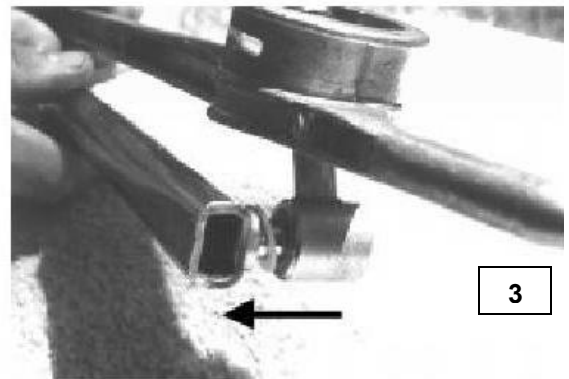
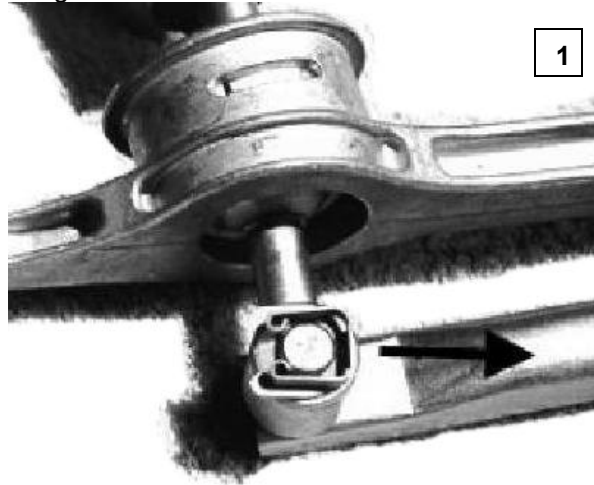



Removing the original shifter from the car

From inside the car, follow the shift lever down until it enters the carrier (that's the cast aluminum piece below the hole in the floor of the car). Locate the nylon cup bushing the surrounds the pivot ball.

Use long needle-nose pliers to rotate the nylon cup bushing. Wedge the tips of the pliers into any two opposite slots in the bushing.

The bushing is held in place by two tabs that will slide out of their slots when the bushing is rotated.

Do not be concerned about damaging the nylon cup. This part will not be re-used.

Once you can see the tabs are free, lift the shifter straight up and out of the console.





Removal of the aluminum carrier and installation of Delrin Carrier Bushings - Done underneath the car.

Our first order of business is to remove the aluminum carrier from the car. Removal of the drive train and exhaust is not necessary except for the

Removal of exhaust center section and heat shields required.

The carrier is connected to the transmission housing by a combination pin/clip at the front. This pin is not obvious by sight; therefore, we have detailed the removal instructions with the carrier already removed from the car so that you can see what is involved.

Now that the shifter lever is removed from the carrier, you will notice that the rear of the carrier (toward the back) is pointy, and slides into a sleeve. This sleeve is a permanent fixture of the car and is filled with an insulating rubber bushing. Go to the other end of the carrier (towards the front of the car) and you will barely see the pin.
(Note: Aluminum carrier and pin have been removed from car to show detail.)

Gain better access to this pin by loosening the transmission cross-brace bolts, allowing the transmission to lower about 1/4".



Top view of the pin



Side view of the pin

As this pin will not be obviously visible or accessible, you will have to study these directions to get an idea for the task at hand. You need to pry up on the pin to "unlock" it from this current horizontal position. This is best done with the flat side of a screwdriver.

Do not be concerned about breaking this clip - a new part has been included with the shifter kit.



Get that blade under the pin



Once you get the blade of the screwdriver under the side of the pin, you need to pry upwards to "unlock" it.



If first you don't succeed, pry, pry again.

Once you've gotten the pin in a more vertical position, you may remove the pin from the carrier.

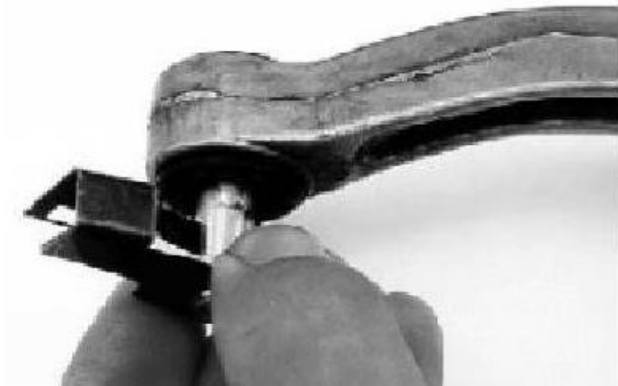

Now that you have removed the pin, you can slide the carrier forwards and backwards to pull it out of the car.

IMPORTANT: A new carrier has been provided with this shifter kit. While it appears identical to the one removed from the car, use the new carrier provided as there is an important modification.



Installation Directions for Delrin Carrier Bushings

Using the new carrier as provided, install the Delrin carrier bushings.

The bushings slip right in on either side of the carrier arm.



As the ID of the Delrin carrier bushings have been machined to a very close tolerance, it is advisable to test fit the new pin (included) through the Delrin carrier bushings.

If you discover that it binds or stops, take a small round file to smooth the transition between the two bushings.

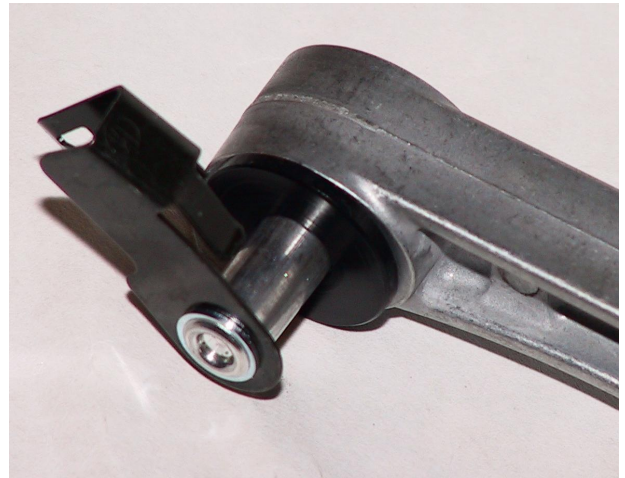



Installation of pivot height adapter assembly (done on the workbench).

Prepare the unit by using some threadlock (included) in the threads of the holes. A small drop in each hole is all you need.



Install the unit into the carrier.

Use the supplied M3 bolts and the 2.5mm Allen key, secure the ERK into the carrier. Install all six bolts **loosely** at first, and then tighten them one at a time, alternating between the two sides.

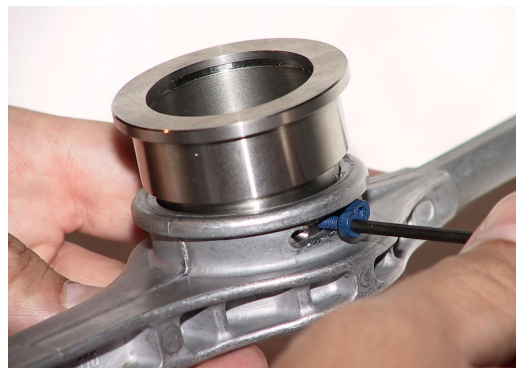

Expanded view.

There is no need to over tighten the locating bolts, as the threadlock and snug fit of the bolts in the carrier will hold them in place. Tighten the bolts between 4 to 6 in/lbs. (NOT ft/lbs!)

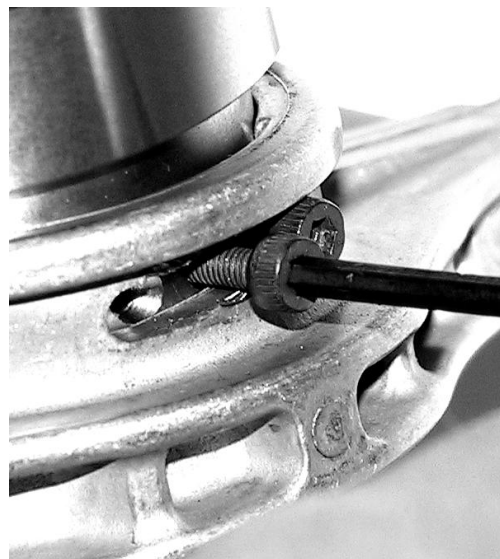

Re-installation of the carrier.

To reinstall the carrier, slip the back end into the rubber bushing affixed to the floorpan as shown:



Replace the front end of the carrier into the fixture at the transmission, use pin/clip to secure. This area can be difficult to see, so you are working "by feel". The pin/clip assembly installs in the reverse manner of removal; slide the pin through the front of the carrier and rotate the clip down until it clicks into place.

If the transmission was lowered for clearance, now raise the transmission to original position and re-install the transmission support.



Shifter installation (done inside of car).

From inside the car, you will see the carrier through the hole in the floor.

Place the **white ring bushing** into the carrier as shown.



IMPORTANT: the bushing has a “cup” shape and must be installed with the cup in the upward orientation as this cutaway diagram:

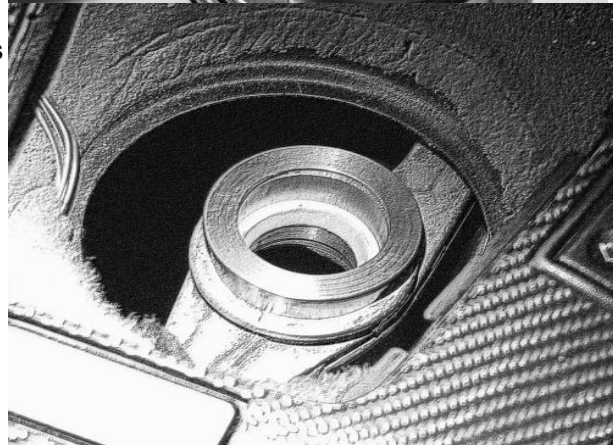
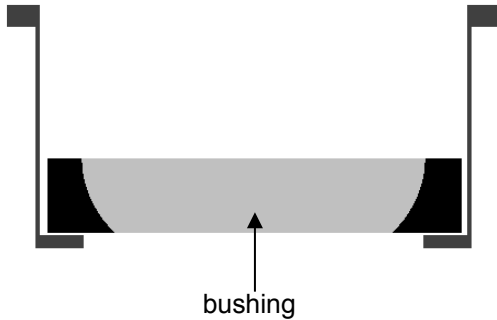



Use the included tube of grease to lubricate the shifter main pivot ball as shown:



Note: the shifter has a compound bend to the overall shape. Correct orientation of the shifter is critical for correct positioning within the shift console.

The shifter's bend should be back and toward the left.

Rotate the shifter until the correct orientation is achieved.

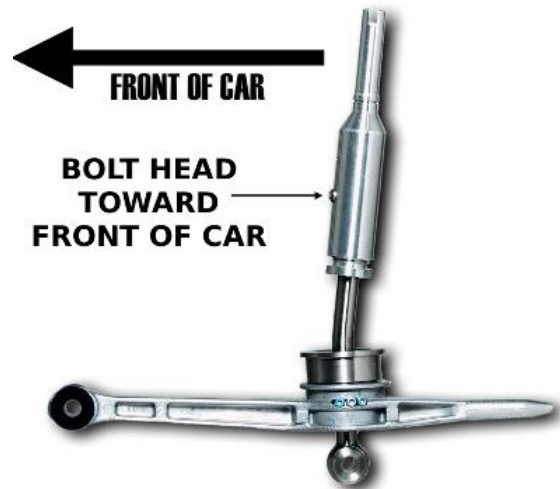



Put the shifter through the carrier.

The shifter has four components above the main pivot ball: upper bushing (**black** in most applications, shown here as white), spring, cap, and C-clip.

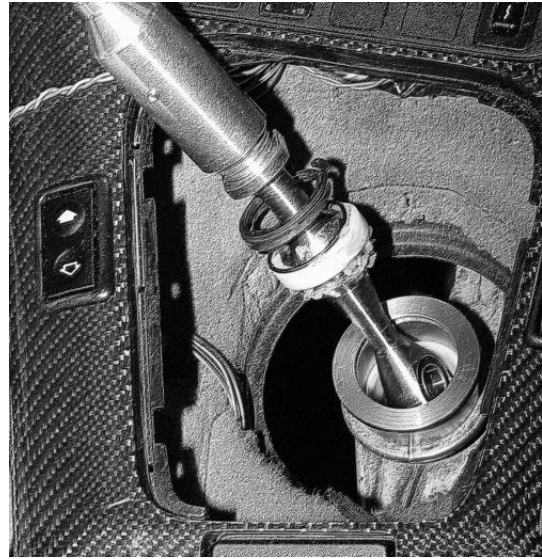

Align these four components so they fit into the pivot height adapter as shown.



Push components in and use C-clip pliers to lock C-clip in the locating groove within the top of the pivot height adapter.

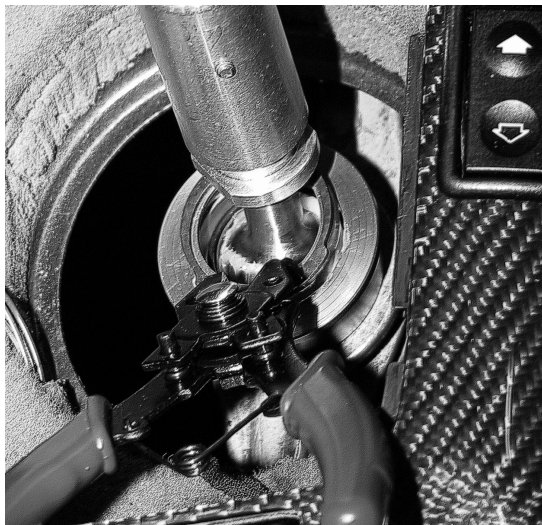



Final result. Make sure clip is securely in groove by pulling up on shifter.





From underneath the car, insert bearing liners into both sides of shifter lower pivot bearings as shown:



Put the yellow washer on the selector rod pin, and affix shifter lower pivot to selector rod with enclosed C-clip.

Back inside the car, re-install rubber inner shifter boot, foam padding, leather boot, and knob (**follow page 3 in reverse order**).

Shifter is fully installed. Check correct installation by going through all gears, feeling for any roughness or binding.

Drive!





Adjusting Lever Height

The height of the lever has been pre-adjusted from UUC to its maximum height. You may lower the height by loosening the locking nut approximately 2 turns (or more if necessary) using a 24mm open-end wrench by turning clockwise (when viewed from above until the lever upper section can be easily moved up and down. Adjust to your preference and re-tighten the locking nut sufficiently to prevent additional movement.

Locking nut for height adjustment.



This is an anti-tamper bolt.

**DO NOT REMOVE
OR ADJUST FOR
ANY REASON.**

warranty VOID if manipulated in any way.



TROUBLESHOOTING:

Shifter sits too far forward or to the right:

Shifter installed backwards. See page 13.

Vibration or noise:

1. Check that the height adjustment locking nut is tight. See page 16.
2. Check that the shifter console inner rubber boot is tucked in completely. See page 4.

Shifter feels loose:

1. Make sure primary pivot clip is in groove. If shifter can be pulled up more than 2mm, the clip is out of place. See page 14.
2. Check that lower pivot bearing liners have been installed. See page 15.

Excessive resistance is felt going into reverse or 5th gear:

Check that the shifter console inner rubber boot is tucked in completely. See page 4.